



ARCADIA REPTILE



PRODUCT DATA SHEET

CADBH

BIRD LAMPHOLDER BRACKET







GENERAL DESCRIPTION - a ceramic lampholder for use with E27 & E26 lamps.

SPECIAL PRECAUTIONS

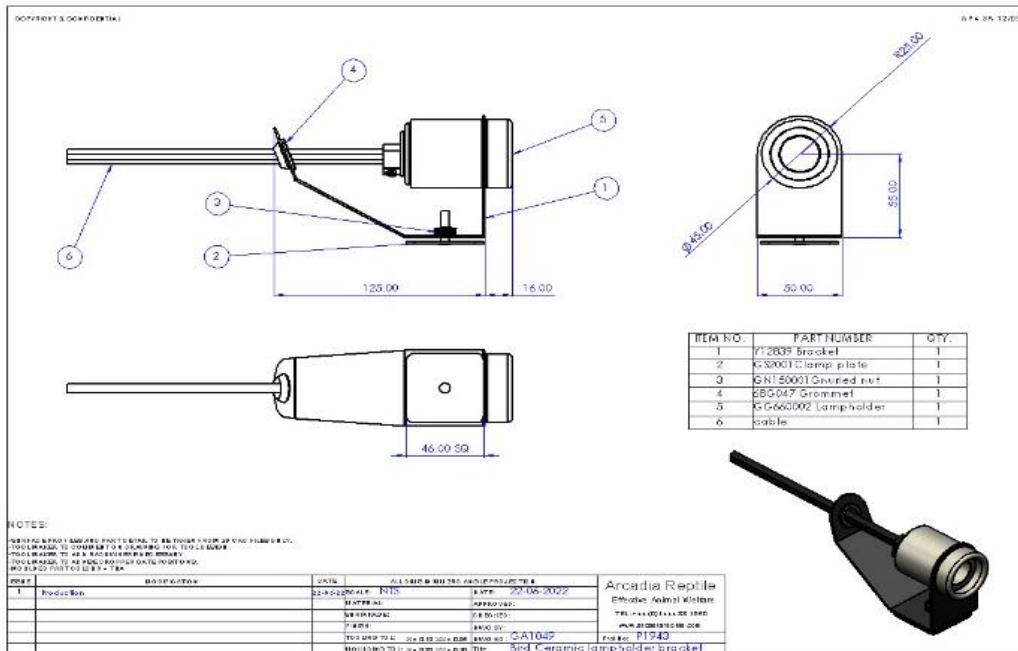
Do not exceed 250W maximum wattage for the lampholder. Take care when screwing lamp into lampholder, do not over tighten.

LUMINAIRE DIMENSIONS







	ARCADIA REPTILE		
	PRODUCT DATA SHEET		
CADBH	BIRD LAMPHOLDER BRACKET		 

MEASUREMENTS (based on supplied lamps)

	Maximum wattage							
	W							
RADCH	250							

COLOUR SPECTRAL CHART wavelength nm

 Monkfield Reptile	ARCADIA REPTILE	
	PRODUCT DATA SHEET	
CADBH	BIRD LAMPHOLDER BRACKET	 

COLOUR RENDER INDEX CHART

TEST EQUIPMENT

Power drawn	Everfine HAAS 1200 array spectroradiometer
Lumen output	Everfine HAAS 1200 array spectroradiometer
Colour temperature	Everfine HAAS 1200 array spectroradiometer
Lux	Iso-Tech Light Meter model 1335
PAR	Apogee PAR meter model MQ-500
UVA	Solarmeter UV Index model 6.5
UVB	Solarmeter UV Index model 6.5
UVC	Solarmeter UVC meter model 8.0
Energy eff. Calcs	EU reg 874/2012 Energy labelling of electrical lamps and luminaires

ADDITIONAL PARTS

HARMONISED STANDARDS

LVD	RoHS
EN60598-1:2008	EN50581:2012
EN60598-2-1:1998	
EN62493:2010	
EMC	
EN55015:2013	
EN61547:2009	
EN61000-3-2:2014	
EN61000-3-3:2013	